

# SP140 Throttle Controller Revision 5/9/2022

## USB

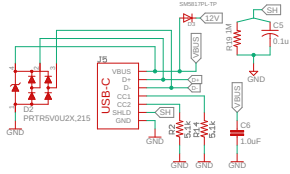

## SPI0

### DISPLAY/BUTTON CONNECTOR

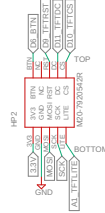

## POT

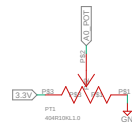

## BUZZER

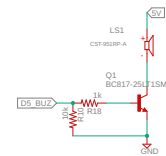

Circled items are not populated on board

## FLASHING

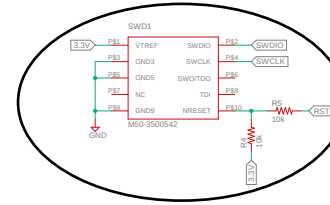

## ALTIMETER

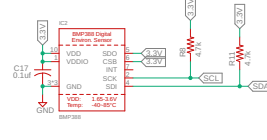

## REGULATED POWER

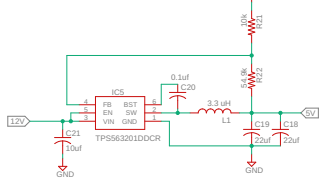

## PROCESSOR

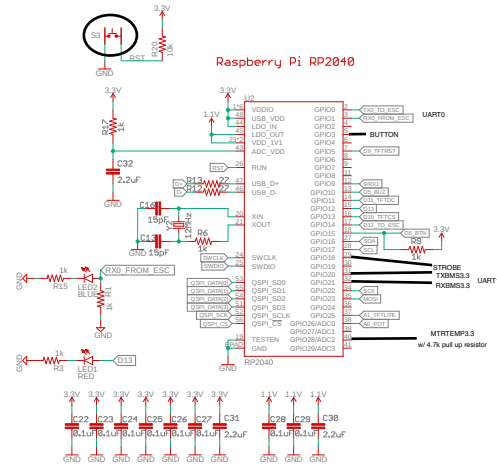

## UART0

### ESC CONNECTOR

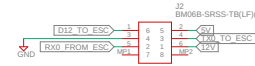

## I2C0

### HAPTIC DRIVER

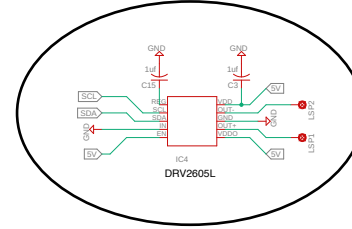

## FLASH

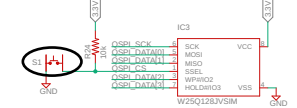

## LEVEL SHIFTER

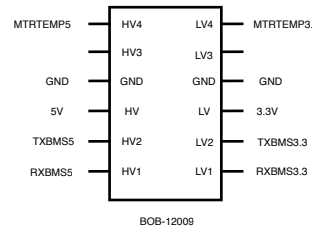

## TEMP SENSOR (MOTOR)

