

# SP140 Throttle Controller

Revision 5/19/2022

## USB

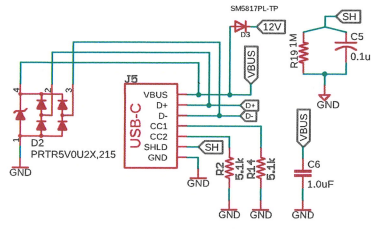

## DISPLAY/BUTTON CONNECTOR

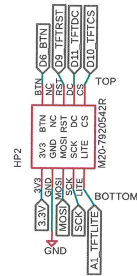

## POT

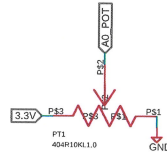

## BUZZER

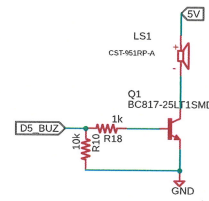

## FLASHING (not populated)

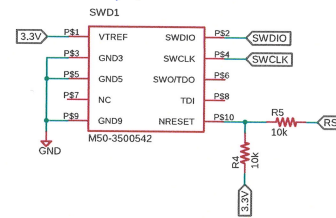

## I2C ALTIMETER

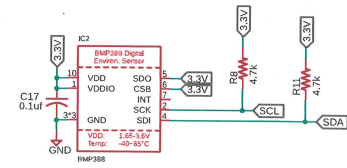

## REGULATED POWER

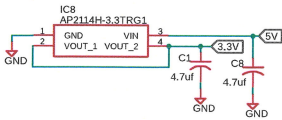
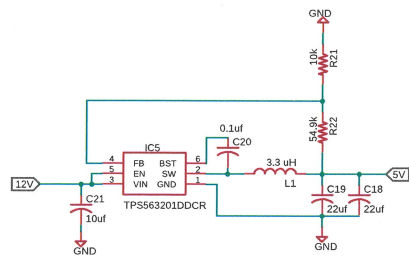

## PROCESSOR

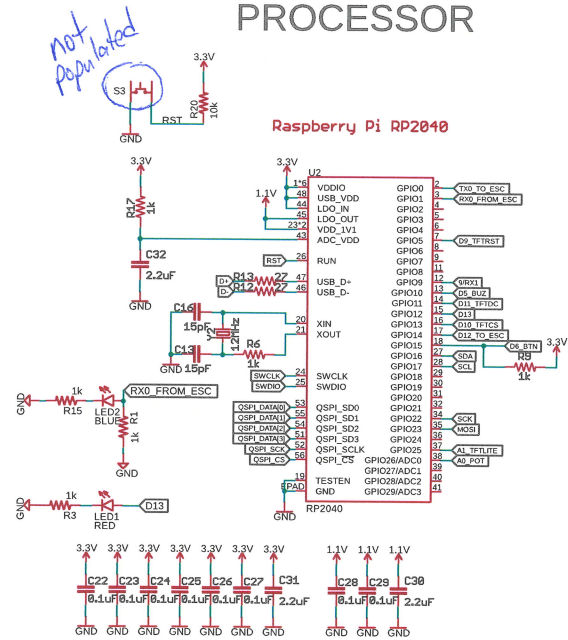

## UART ESC CONNECTOR

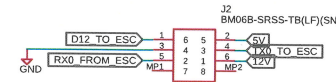

## I2C HAPTIC DRIVER (not populated)

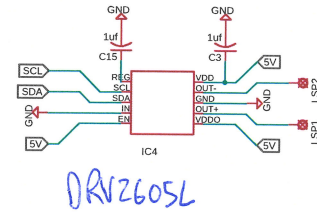

## FLASH

